

XMOZU X Series

X4 - i

4mm pixel pitch, Indoor Smart LED Display

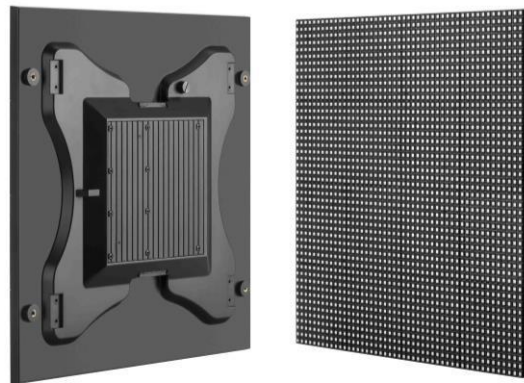





About X4-i

X4-i is an intelligent, modular splicing LED display. There are power and lamp board in one module (3 in 1 - lamp, drive and system). X4-i is light and thin with single signal line which is easy for splicing.

X4-i is a civilian intelligent DIY product which can be controlled by mobile phone and tablet.

Product Advantages

-  **DIY splicing freely**
It meets the demand for DIY modules of end clients, and can splice various models easily like the children play toy bricks, making LED display really step into commercial or civil market.
-  **Smart, mobile phone controls**
X4-i is already a terminal product. Users don't have to bother to study technology of it. With goodish APP from YDEA, the display can be easily controlled and played by mobile phone or tablet.
-  **Front-maintenance with spring structure**
X4-i is designed with simplified installation structure, matched with only one cable. X4-i is mounted to the fixed bracket, which only needs the push from your hands, then installation and maintenance can be completed.
-  **Light and thin. Lamp board, system and drive are integrated into one module (3 in 1)**
X4-i integrates power, lamp board, drive and system into one module, which makes the size of the module to be only 320*320mm. And the weight is only 1.65Kg.

parameter

1. Unit size

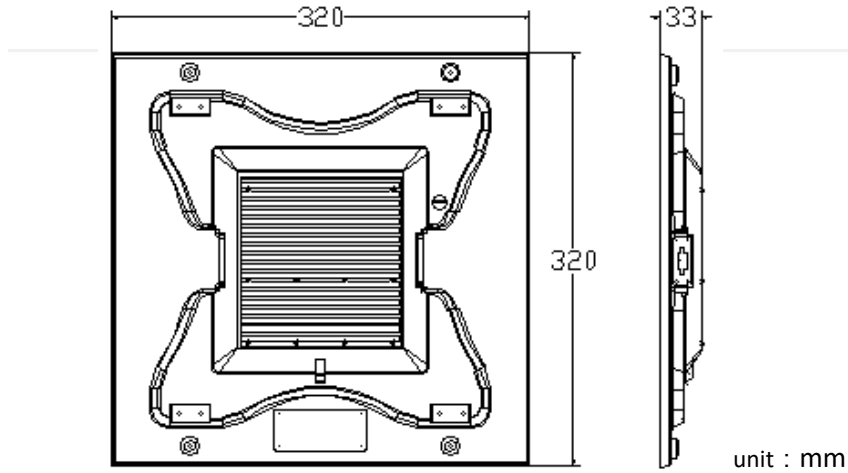

2. Technology parameter

X4 - i	
Pixel pitch (mm)	4
Pixel density (dot)	6400
Module size (mm)	320 x320 x33
Module pixel (dot)	80x80
Pixel configuration	1R1G1B
LED encapsulation	SMD2121
Brightness (nits)	≥1200
Luminous efficiency (%)	≥93%
Angle of view (degrees)	120
Contrast ratio	5000:1
Gray level (bit)	14
Scanning mode	1/16
Refresh frequency (Hz)	3840
Repetition frequency (Hz)	60
Maintenance mode	Front/ Back maintenance
Control mode	Synchronous and asynchronous control
Splicing module	1*1、1*2、1*3
IP grade	IP42
Working voltage (VAC)	100/240
Max consumption	60
Working environment (degree C)	-30~55
Weight (Kg/Pcs)	1.65

Installation

1 Hanging Installation Procedure



1.Hanging Tube and panel Assembling



2.Splice X4-i Panel ;

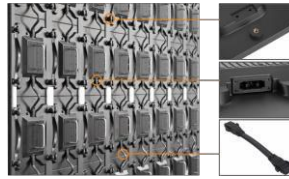

3.Connect Power&Signal 2 in 1 cable ;



4.Hanging screen ;

2 Front Maintenance Installation Procedure



1.Fix Front maintenance frame on wall ;

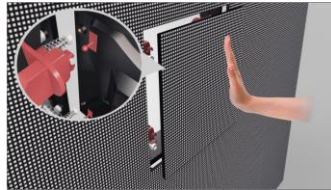

2.Press to install



3.Connect Power&Signal 2 in 1 cable ;



4. Fix screen on wall ;



5.Front maintenance screen ;

3 Simple fixed Installation Procedure



1. Splice X4- i panel ;



2. Connect Power&Signal 2 in 1 cable ;



3. Fix screen on wall ;

Data connecting diagram

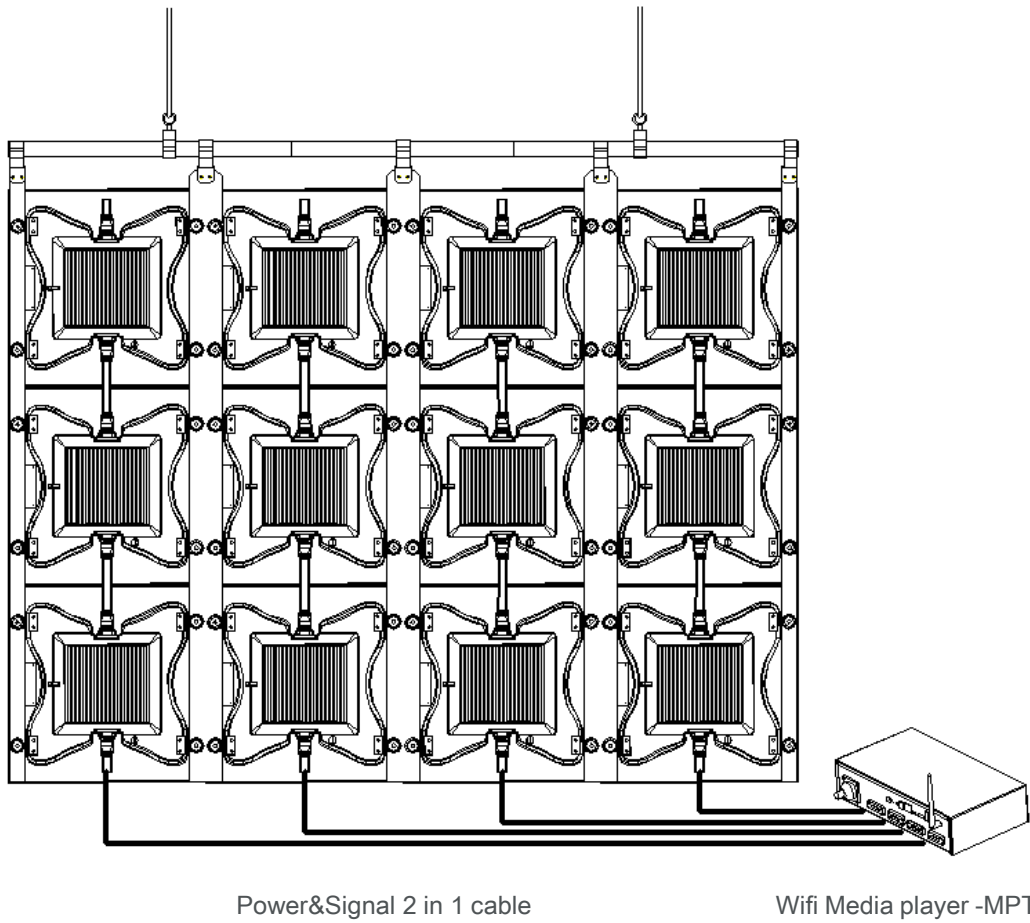

Produced in : 22nd Dec. 2016
Will not advice when parameter adjusted.
Please enter www.xmozu.com for last product information.